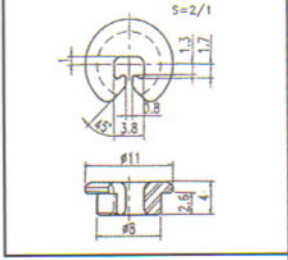

D/No. **51343-00**
 NAME: Barmag(2909944)
 MATE: TSO

2.00g

D/No. **51802-00**
 NAME: Barmag
 MATE: TS2

0.80g

D/No. **83307-00**
 NAME: Barmag(4013452)
 MATE: TSO

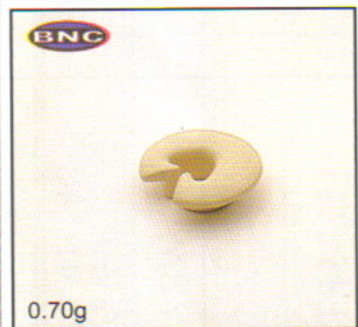
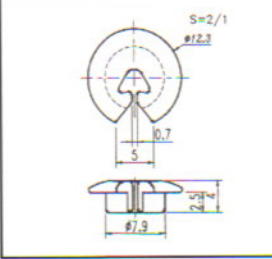
0.70g

D/No. **51595-00**
 NAME: Barmag(2155572)
 MATE: ASO

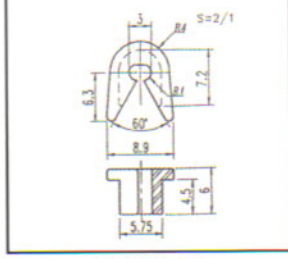
0.75g

D/No. **83223-00**
 NAME: Barmag
 MATE: ASO

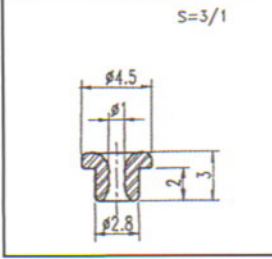
0.087g

D/No. **63604-18**
 NAME: Barmag(2907954)
 MATE: TSO

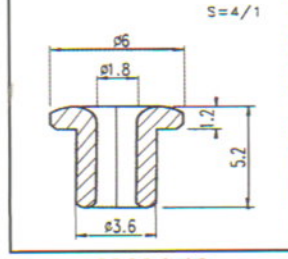
1.00g

D/No. **69507-62**
 NAME: Barmag
 MATE: ASF

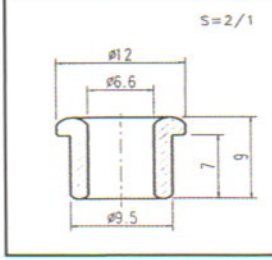
1.60g

D/No. **69557-55**
 NAME: Barmag(3652719)
 MATE: ASW

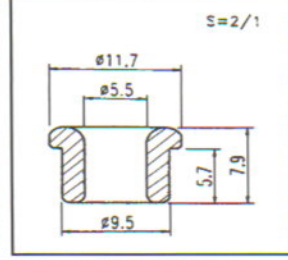
1.70g

D/No. **50113-78**
 NAME: Barmag
 MATE: AOO

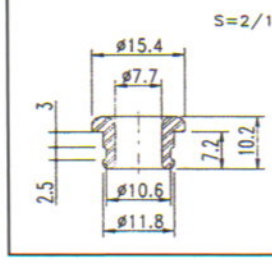
3.00g

D/No. **61475-10**
 NAME: Barmag
 MATE: AOO

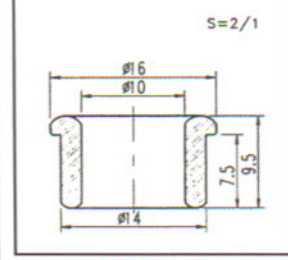
3.00g



BNC

S=2/1

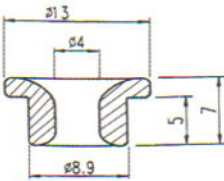

D/No. **68905-40**
 NAME: Barmag(2909146)
 MATE: TSO

1.08g



BNC

S=2/1

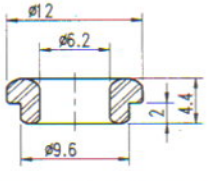

D/No. **69602-62**
 NAME: Barmag
 MATE: ASF

0.97g



BNC

S=1/1

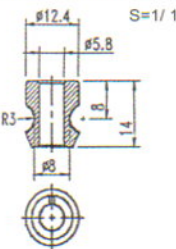

D/No. **76141M02**
 NAME: Barmag
 MATE: ASO

3.60g



BNC

S=2/1

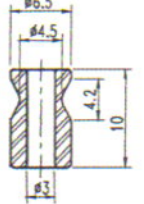

D/No. **76247-00**
 NAME: Barmag
 MATE: ASO

0.80g



BNC

S=1/1

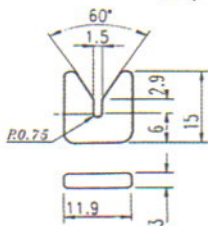

D/No. **76008-00**
 NAME: Barmag(3142308)
 MATE: TSO

1.50g



BNC

S=2/1

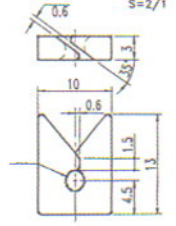

D/No. **83074-00**
 NAME: Barmag(5805453)
 MATE: ASO

1.10g



BNC

S=2/1

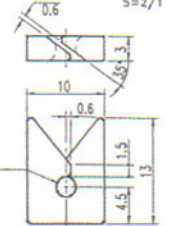

D/No. **83203-00**
 NAME: Barmag
 MATE: ASO

1.20g



BNC

S=1/1

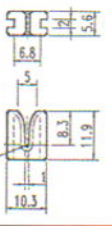

D/No. **83077-00**
 NAME: Barmag(2855876)
 MATE: TSO

2.00g



BNC

S=1/1

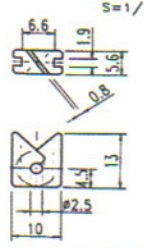

D/No. **83034-00**
 NAME: Barmag(5806294)
 MATE: ASW

1.60g



BNC

S=1/1

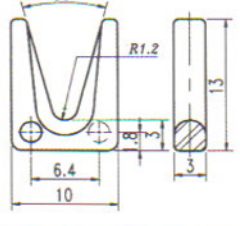

D/No. **83362-00**
 NAME: Barmag(5806514)
 MATE: ASW

0.80g



BNC

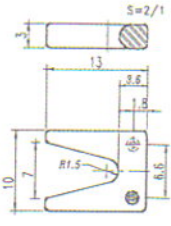

D/No. **83291-00**
NAME: Barmag(5806514)
MATE: ASW

0.80g



BNC

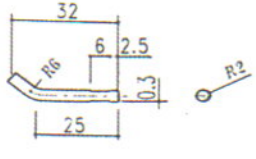

D/No. **80039-00**
NAME: Barmag(3169373)
MATE: TSO

1.50g



BNC

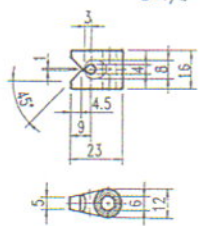

D/No. **83228-00-**
NAME: Barmag(3657982)
MATE: ASW

8.80g



BNC

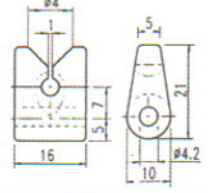

D/No. **83079-00**
NAME: Barmag
MATE: TSO

7.40g



BNC

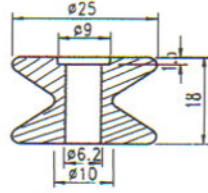

D/No. **53258-00**
NAME: Barmag(2750961)
MATE: TSO

20.0g



BNC

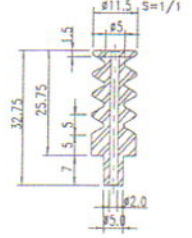

D/No. **76101M00**
NAME: Barmag
MATE: AOO

6.80g



BNC

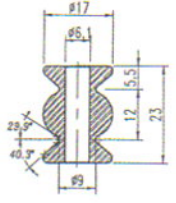

D/No. **53173-60**
NAME: Barmag(2364232)
MATE: TSO

12.3g



BNC

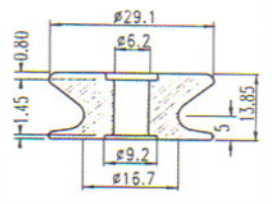

D/No. **53294-00**
NAME: Barmag(3650089)
MATE: ASW

23.0g



BNC

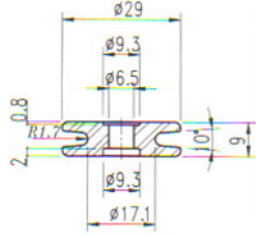

D/No. **53299-61**
NAME: Barmag
MATE: ASW

18.0g



BNC

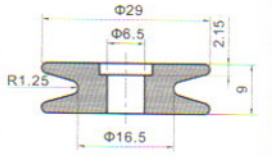

D/No. **53299-60**
NAME: Barmag(5801312)
MATE: ASW

18.0g

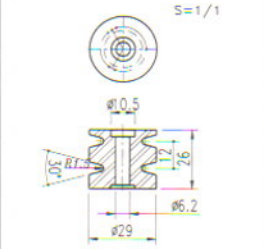
D/No. **53297-2W**
 NAME: Barmag
 MATE: ASW2

D/No. **76344-00**
 NAME: Barmag
 MATE: AS2

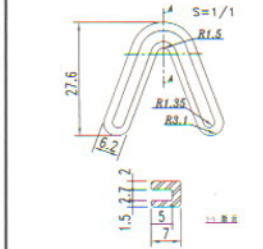
D/No. **83438-00**
 NAME: Barmag
 MATE: ASW2

D/No. **76027-00**
 NAME: Barmag
 MATE: ASW

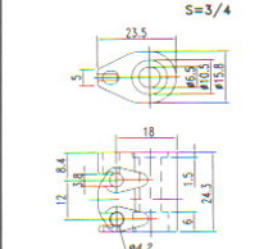
D/No. **83443-00**
 NAME: Barmag(3142308)
 MATE: ASW2

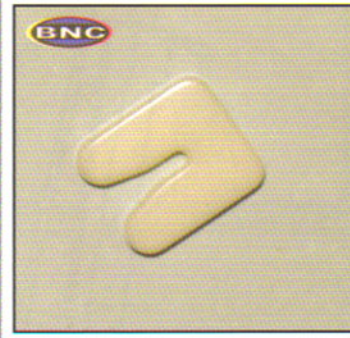
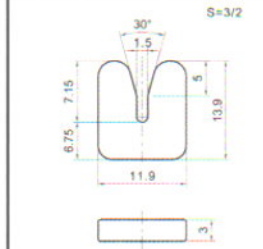

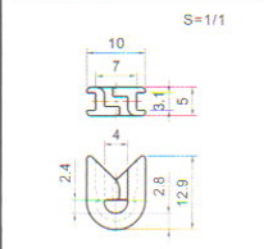

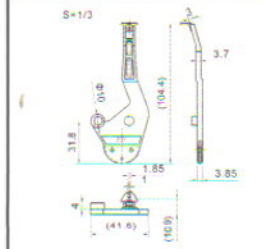
D/No. **J-TR-AFK-1**
 NAME: Barmag(5805453)
 MATE: ASO

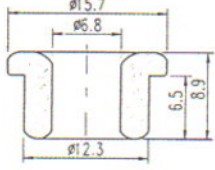

BNC

S=2/1



D/No. **61265-68**
NAME: ICBT
MATE: TSO

2.735g



BNC

S=2/1

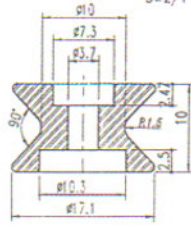

D/No. **53170-35**
NAME: ICBT
MATE: TSO

4.80g



BNC

S=1/1

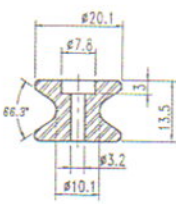

D/No. **53213-00**
NAME: ICBT
MATE: TSO

8.40g



BNC

S=1/1

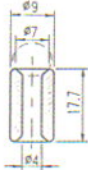

D/No. **49018N40**
NAME: ICBT
MATE: TSO

3.351g



BNC

S=1/1

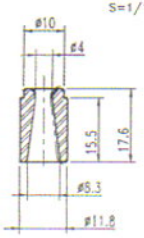

D/No. **76039-00**
NAME: ICBT
MATE: TSO

5.175g



BNC

S=2/1

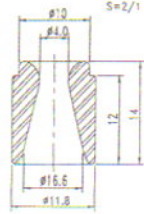

D/No. **76145M00**
NAME: ICBT
MATE: TSO

4.23g



BNC

S=1/1

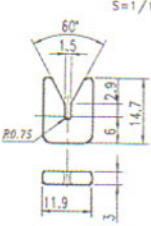

D/No. **76008-00**
NAME: ICBT/Barmag
MATE: TSO

1.50g



BNC

S=1/1

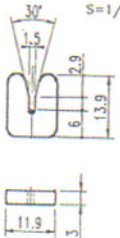

D/No. **76027-00**
NAME: ICBT
MATE: TSO

1.60g



BNC

S=1/1

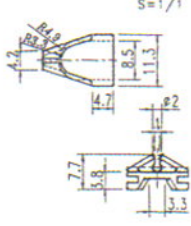

D/No. **83206-00**
NAME: ICBT
MATE: TSO

1.49g



BNC

S=3/1

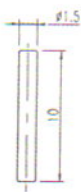

D/No. **21510R00**
NAME: ICBT
MATE: AOO

0.058g

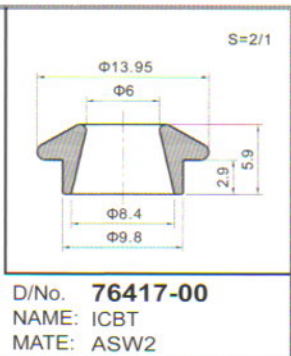
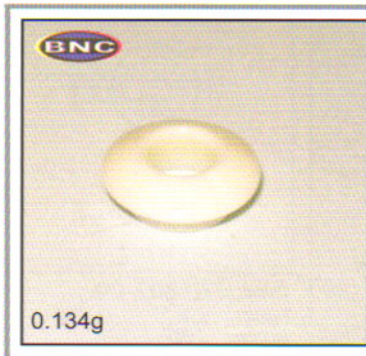

D/No. **76417-00**
NAME: ICBT
MATE: ASW2

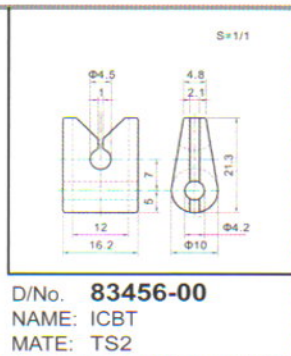

D/No. **83456-00**
NAME: ICBT
MATE: TS2



BNC

S=2/1

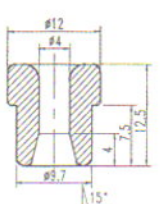

D/No. **74019-00**
NAME: Murata(33H-722-021)
MATE: ASW

3.40g



BNC

S=1/1

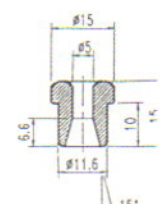

D/No. **74026-00**
NAME: Murata
MATE: ASW

5.60g



BNC

S=1/1

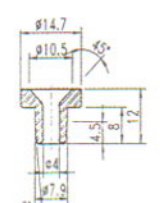

D/No. **74011-00**
NAME: Murata(33F-421-007)
MATE: ASO

3.00g



BNC

S=2/1

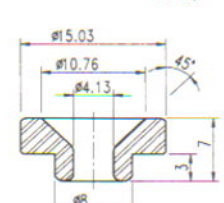

D/No. **74011H70**
NAME: Murata
MATE: AS2

0.40g



BNC

S=1/1

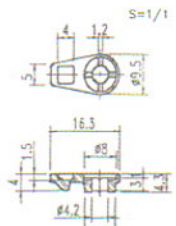

D/No. **83010-00**
NAME: Murata(33J-181-001)
MATE: ASO

1.10g



BNC

S=2/1

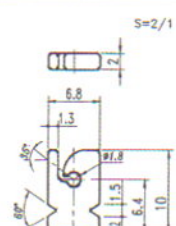

D/No. **76022-00**
NAME: Murata
MATE: ASO

0.40g



BNC

S=1.5/1

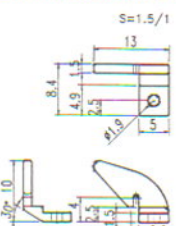

D/No. **83241-00**
NAME: Murata(33H-3095A-50-2)
MATE: ASO

0.40g



BNC

S=2/1

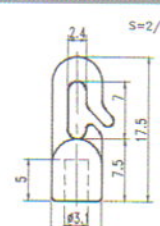

D/No. **83186-00**
NAME: Murata
MATE: ASO

1.40g



BNC

S=2/1

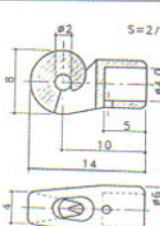

D/No. **80021-00**
NAME: Murata(33F-182-001)
MATE: ASO

0.90g



BNC

S=2/1

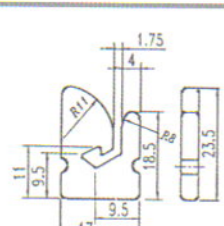

D/No. **80040-00**
NAME: Murata(33F-171-008)
MATE: ASW

3.95g

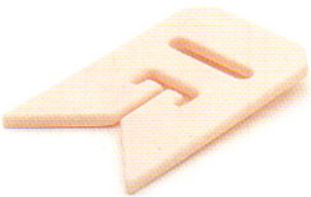
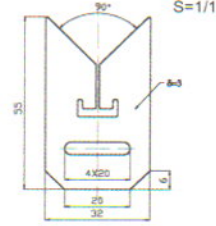
D/No. **83364-00**
NAME: Murata(33F-421-011)
MATE: ASO

15.59g

D/No. **76138-00**
NAME: Murata(33F-421-004)
MATE: ASO

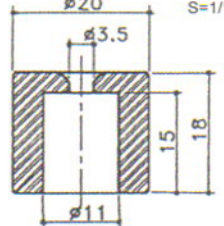
15.4g

D/No. **83244-00**
NAME: Murata(33F-342-004)
MATE: ASO

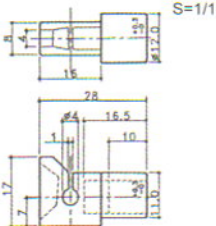
6.60g

D/No. **83249-00**
NAME: Murata(33F-421-011)
MATE: ASO

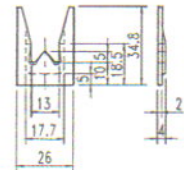
5.20g

D/No. **83251-00**
NAME: Murata(33H-722-021)
MATE: ASW

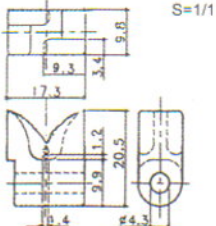
8.20g

D/No. **83018-00**
NAME: Murata(33F-181-001)
MATE: ASO

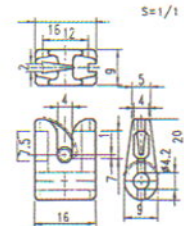
5.00g

D/No. **83240-00**
NAME: Murata(33H-440-002)
MATE: ASF

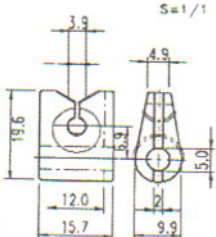
6.00g

D/No. **83250-00**
NAME: Murata(33F-440-002)
MATE: ASO

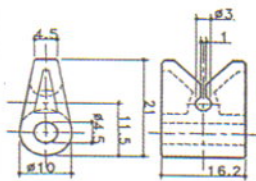
6.00g

D/No. **84053-00**
NAME: Murata(33J-181-001)
MATE: ASO

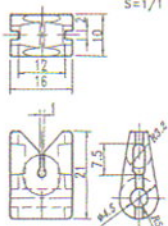
6.20g

D/No. **84054-00**
NAME: Murata(33J-182-001)
MATE: ASO

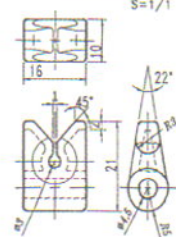
6.00g

BNC

D/No. **74074-00**
NAME: Murata
MATE: ASO

30.0g

BNC

D/No. **74073-00**
NAME: Murata
MATE: ASO

24.0g

BNC

D/No. **J-83241-L**
NAME: Murata
MATE: ASO · PA

8.20g

BNC

D/No. **J-83241-R**
NAME: Murata
MATE: ASO · PA

8.20g

BNC

D/No. **53218M2W**
NAME: Murata
MATE: ASW2

8.20g

BNC

D/No. **83433-00**
NAME: Murata
MATE: AS2

8.20g

BNC

D/No. **83416-00**
NAME: Murata
MATE: ASO

BNC

D/No. **83251-00**
NAME: Murata(33F-400-013)
MATE: ASW

BNC

D/No. **83477-00**
NAME: Murata(33J-420A-004)
MATE: AS2

BNC

D/No. **83501-00**
NAME: Murata(33F-420-018)
MATE: AS2

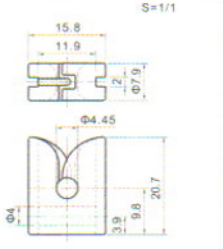
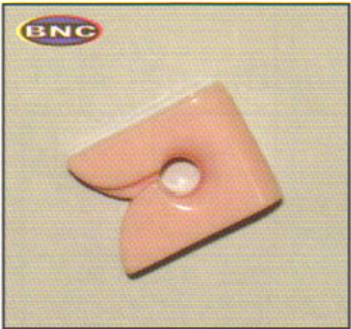

D/No. **84034-00**
NAME: Murata
MATE: AS2

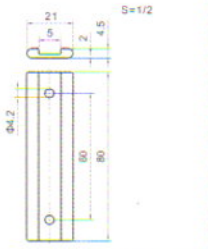
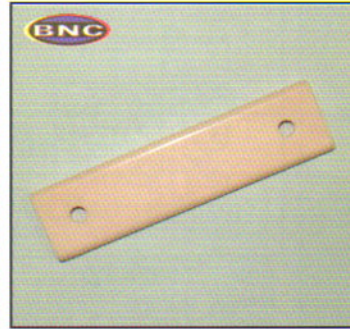

D/No. **84084-00**
NAME: Murata
MATE: AS2



BNC

S=2/1

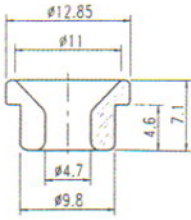

D/No. **69805-47**
NAME: Scragg(211-00076)
MATE: AOO

1.70g



BNC

S=2/1

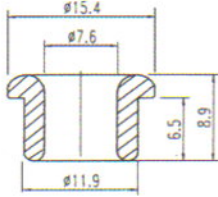

D/No. **61265-78**
NAME: Scragg(211-00028)
MATE: ASW

2.76g



BNC

S=2/1

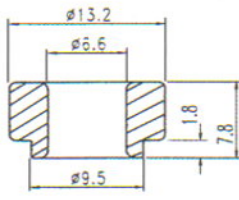

D/No. **69502-66**
NAME: Scragg
MATE: TSO

2.60g



BNC

S=2/1

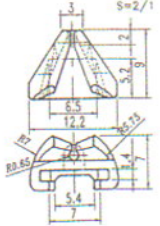

D/No. **83280-00**
NAME: Scragg(211-00010)
MATE: ASW

0.86g



BNC

S=1/1

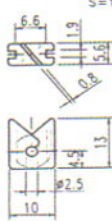

D/No. **83034-00**
NAME: Scragg(211-00082)
MATE: ASW

1.60g



BNC

S=1/1

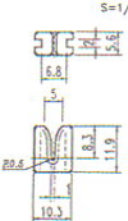

D/No. **83077-00**
NAME: Scragg(370-10742)
MATE: TSO

2.00g



BNC

S=1/1

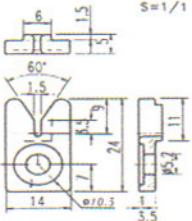

D/No. **83084-00**
NAME: Scragg(438-00284)
MATE: TSO

3.40g



BNC

S=1/1

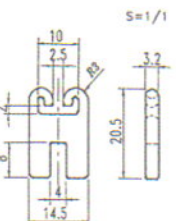

D/No. **76289-00**
NAME: Scragg
MATE: TSO

2.50g



BNC

S=1/2

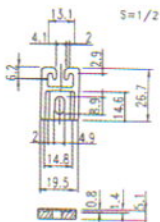

D/No. **76186-00**
NAME: Scragg(211-00065)
MATE: ASW

7.00g



BNC

S=1/1

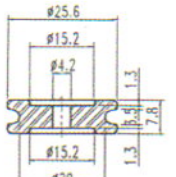

D/No. **53257-42**
NAME: Scragg(211-00014)
MATE: ASW

11.65g



BNC

6.20g

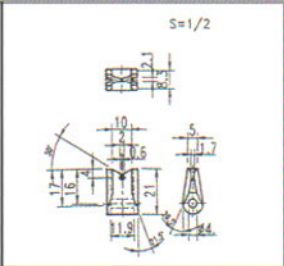

S=1/2

D/No. **83293-00**
NAME: Scragg(211-0007-02)
MATE: ASW



BNC

7.40g

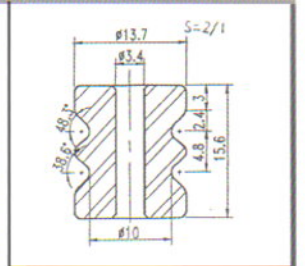

S=2/1

D/No. **53135-34**
NAME: Scragg(419-00066)
MATE: TSO



BNC

4.30g

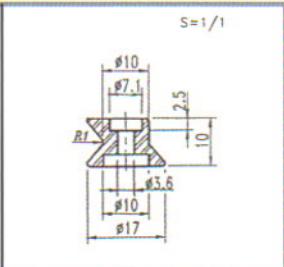

S=1/1

D/No. **53171M36**
NAME: Scragg(211-00036)
MATE: TSO



BNC

7.40g

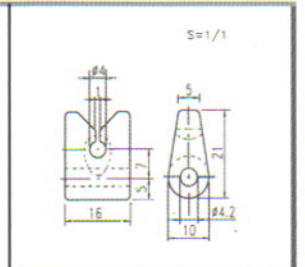

S=1/1

D/No. **83079-00**
NAME: Scragg(211-00012)
MATE: TSO



BNC

4.60g

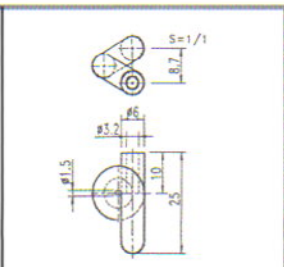

S=1/1

D/No. **83129-L0**
NAME: Scragg(370-10719)
MATE: ASW



BNC

4.60g

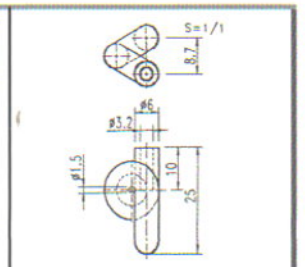

S=1/1

D/No. **83129-R0**
NAME: Scragg(370-10719)
MATE: ASW



BNC

0.80g

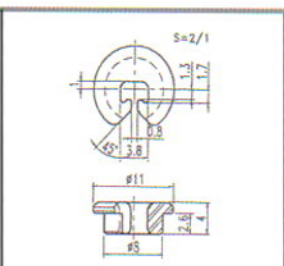

S=2/1

D/No. **51802D11**
NAME: Scragg(211-00038)
MATE: ASW

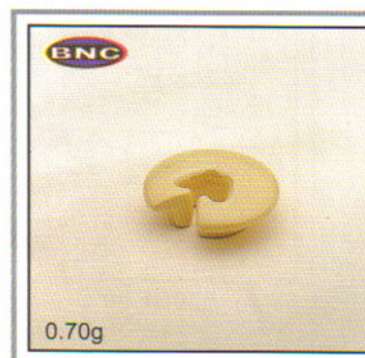

BNC

0.70g

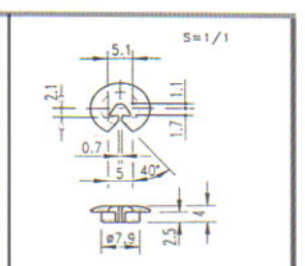

S=1/1

D/No. **83307-00**
NAME: Scragg(211-0009)
MATE: TSO



BNC

1.60g

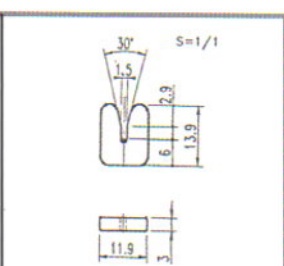

S=1/1

D/No. **76027-00**
NAME: Scragg
MATE: TSO



BNC

1.60g

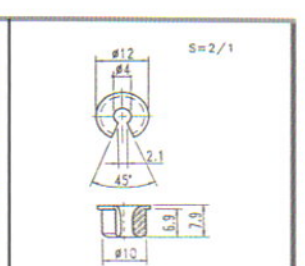

S=2/1

D/No. **51107-00**
NAME: Scragg(211-00090)
MATE: ASO

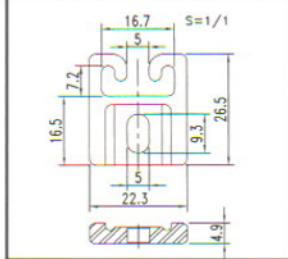
D/No. **76349-00**
 NAME: Scragg
 MATE: TS2

D/No. **83432-LO**
 NAME: Scragg
 MATE: ASW2

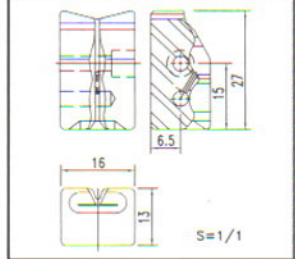
D/No. **83432-RO**
 NAME: Scragg
 MATE: ASW2

D/No. **83442-LO**
 NAME: Scragg
 MATE: ASW2

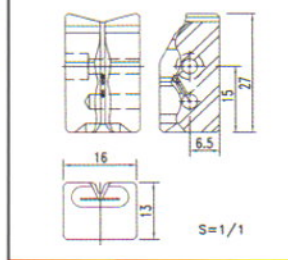
D/No. **83442-RO**
 NAME: Scragg
 MATE: ASW2

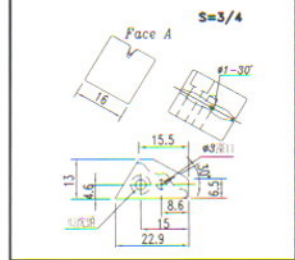
D/No. **76479-00**
 NAME: Scragg
 MATE: TS2

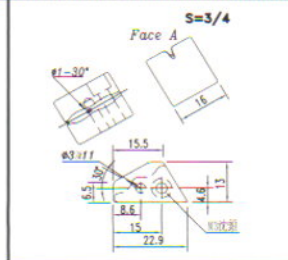
D/No. **J-626-T2**
 NAME: Scragg
 MATE: ASW2

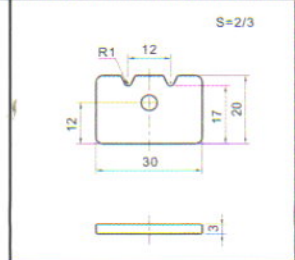
D/No. **83129-L0**
NAME: TEIJIN
MATE: ASF

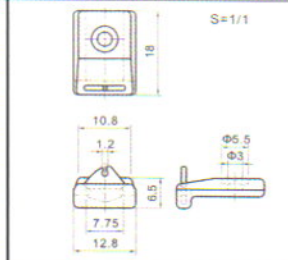
D/No. **80031-00**
NAME: TEIJIN
MATE: ASO

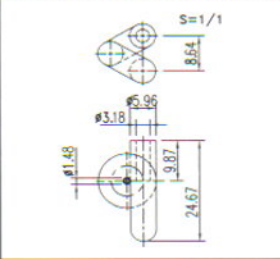
D/No. **53221M35**
NAME: TEIJIN
MATE: AS2

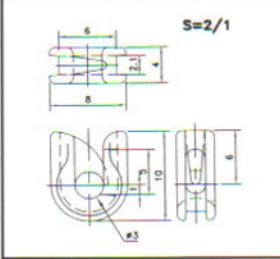
D/No. **J-83354-10-840**
NAME: TEIJIN
MATE: AS2 . BEA

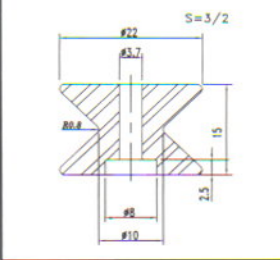
D/No. **53170-35**
NAME: TEIJIN
MATE: TS2

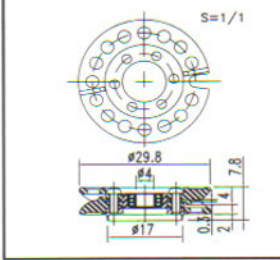
D/No. **83463-AT**
NAME: TEIJIN
MATE: AS2

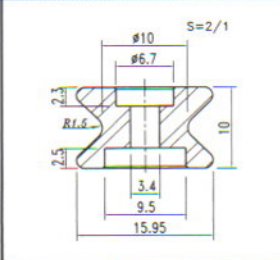
D/No. **83228-03**
NAME: TEIJIN
MATE: TS2

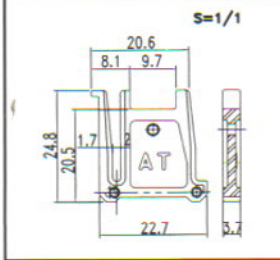
D/No. **83307-00**
NAME: TEIJIN
MATE: ASW

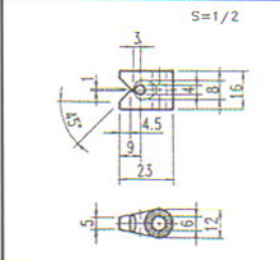
D/No. **76400-00**
NAME: TEIJIN
MATE: AS2

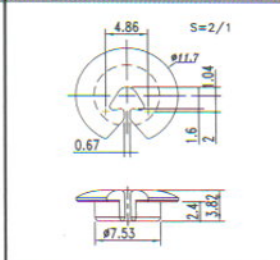
D/No. **83018-00**
NAME: TEIJIN
MATE: AS2

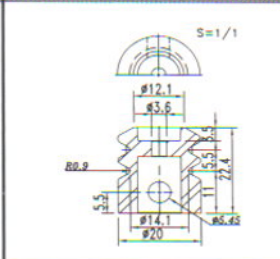
D/No. **83119-00**
 NAME: TEIJIN
 MATE: ASO

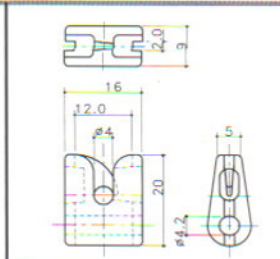
D/No. **83392-00**
 NAME: TEIJIN
 MATE: AS2

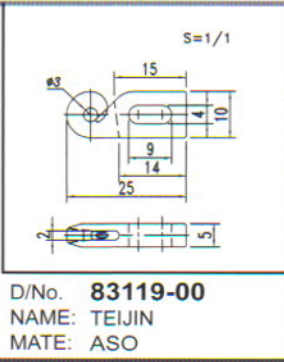
D/No. **84040-00**
 NAME: TEIJIN
 MATE: AS2

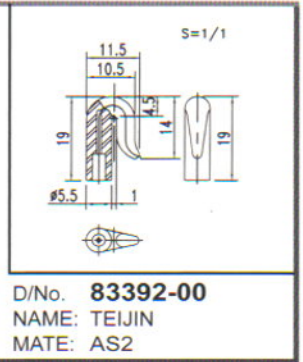
D/No. **83426-00**
 NAME: TEIJIN
 MATE: ASW2

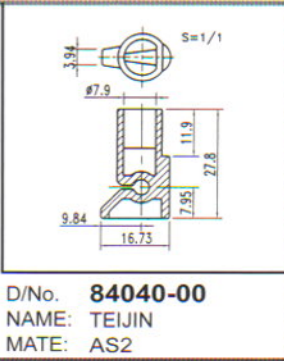
D/No. **83077-00**
 NAME: TEIJIN
 MATE: TS2

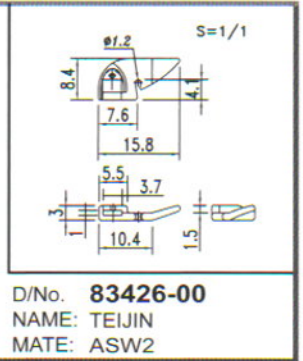
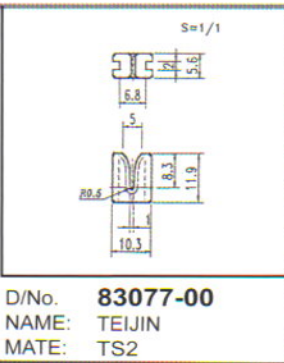
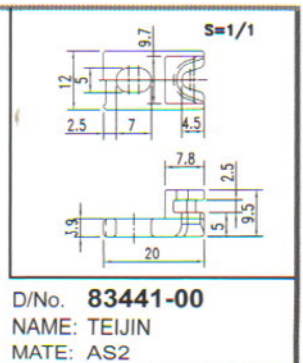
8.20g
 D/No. **83441-00**
 NAME: TEIJIN
 MATE: AS2